



FASHION SHOW '09			

Tourist Benefits

- Basic Information**
Basic Information for the Tourist
- For You!**
It is possible to get a 10% discount on the entrance fee for the Tourist. For the Tourist, the entrance fee is 10% of the entrance fee for the Tourist.
- Additional**
at the entrance, the Tourist can get a 10% discount on the entrance fee for the Tourist.

LIFE'S GOOD WHEN YOU DISPLAY YOUR BEST

www.LGcommercial.com



INNOVATIVE AS LG

LG Electronics Business Solutions Division is a leading business-to-business (B2B) manufacturer, developing premium digital devices and solutions including LCD monitors, commercial displays, A/V accessories, and digital storage. Comprised of more than 84,000 employees, LG's workforce operates in 115 locations, including 84 subsidiaries around the world. In 2008, LG reached \$4.3 billion in global commercial sales and is poised to anticipate future business trends for continued rapid growth. LG provides unique products and services that offer smart and reliable solutions to meet the needs of business partners and customers.

Delivering on our commitment to innovation, LG Electronics recognizes the importance of flat panel display technology when used to communicate, engage and entertain. With the explosive growth of applications like digital signage, interactive displays connect with consumers more than ever before: for wayfinding, travel information, dynamic advertising, message boards and corporate communications. The digital signage market is projected to grow to more than \$4 billion* by 2010. The LG Commercial Products division has the dedicated staff and technical expertise to grow with you as your needs evolve. With a broad range of displays, superior service, and the distinct advantage of having LG experts who understand what makes each industry unique, LG is a complete solutions provider. Digital signage solutions as innovative as LG.

PERFECT FIT FOR DIGITAL SIGNAGE

Digital signage may aid sales growth while enhancing customer entertainment and education in retail and public display environments. LG understands the complexity involved with implementing and deploying a dynamic digital signage network.

As a leader in solutions for digital signage applications, LG offers a wide range of LCD displays that can aid your business in reaching its goals.

Select LG LCD displays offer:

- Portrait or landscape orientation
- Video wall configuration
- HD display resolution
- The latest in computer connections
- LG's exclusive Super IPS™ Technology for wide viewing angles
- LG's exclusive XD Engine® for boosting brightness, contrast, detail, color, and reducing noise

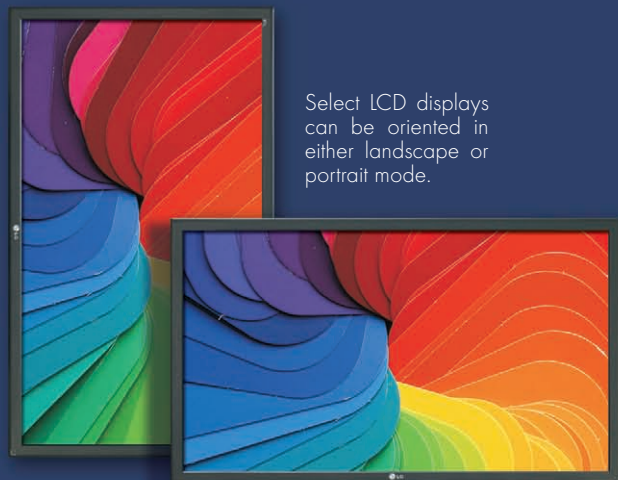

Select LCD displays can be oriented in either landscape or portrait mode.



DELIVERING DIGITAL CONTENT

LG understands the time, research and cost involved to produce a perfect message. This message depends on first impressions. First impressions come from the viewers' experience. Clarity and the how this message fits into its environment will hold attention and deliver clearly the point intended.

LG has a wide range of LCD displays that were designed to engage the customer in the venue where they are placed. The M3202T, M4212T, and M4714T touch screen supplies and delivers information from a touch of a fingertip and makes way-finding a snap! The exciting M4210D 3D monitor will not only capture curiosity but also give the viewer a more dimensional view of the product being sold. Unique applications that involve side-by-side messaging or special size restrictions can take advantage of the M2900S and M3800S stretch screen monitors.

M4210D 3D MONITOR

Perfect for use in theater lobbies for 3D movies and mall kiosks for product attention grabbers. Utilizes content from still images, dynamic animation, 2D and 3D movies.



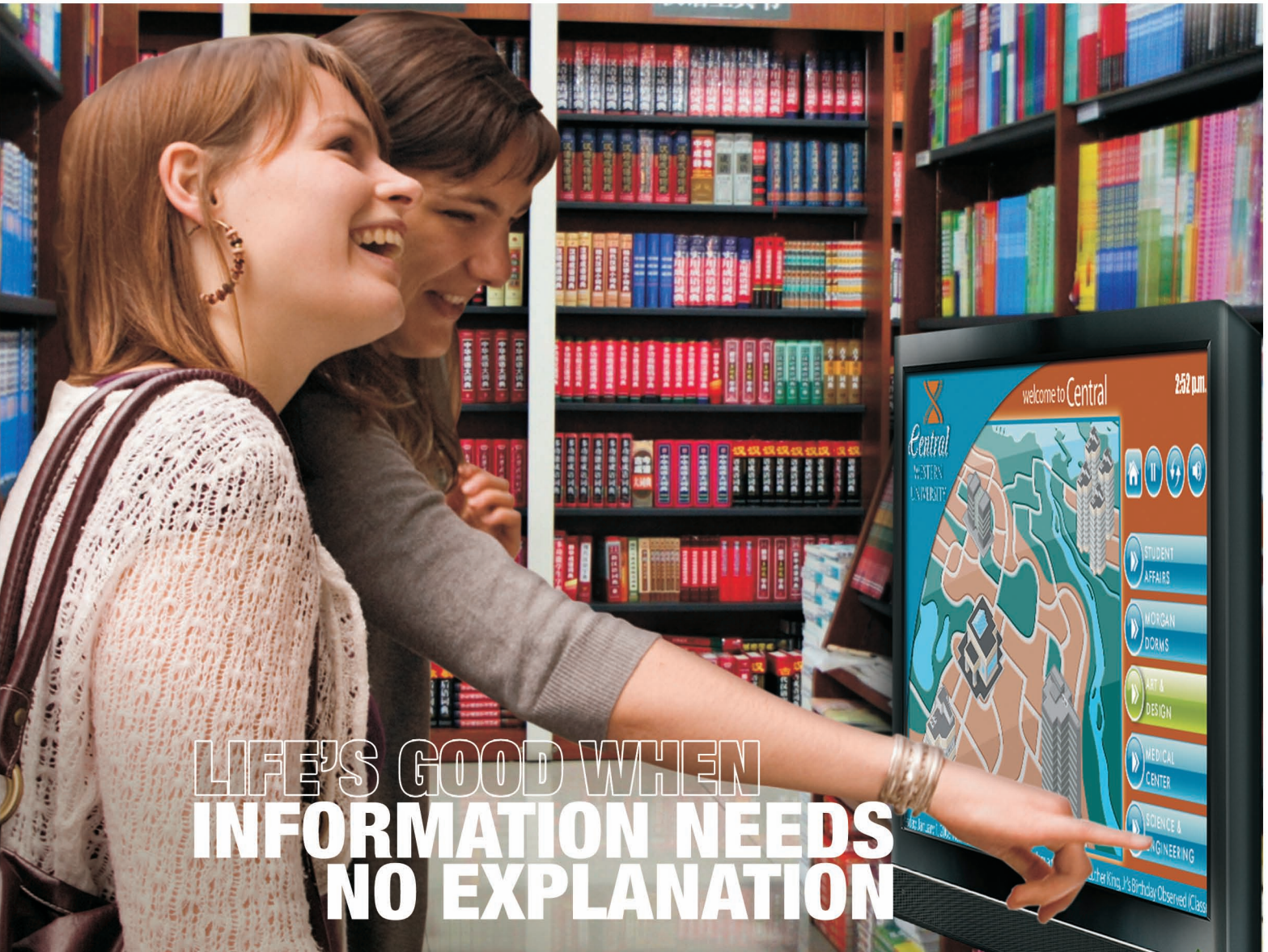

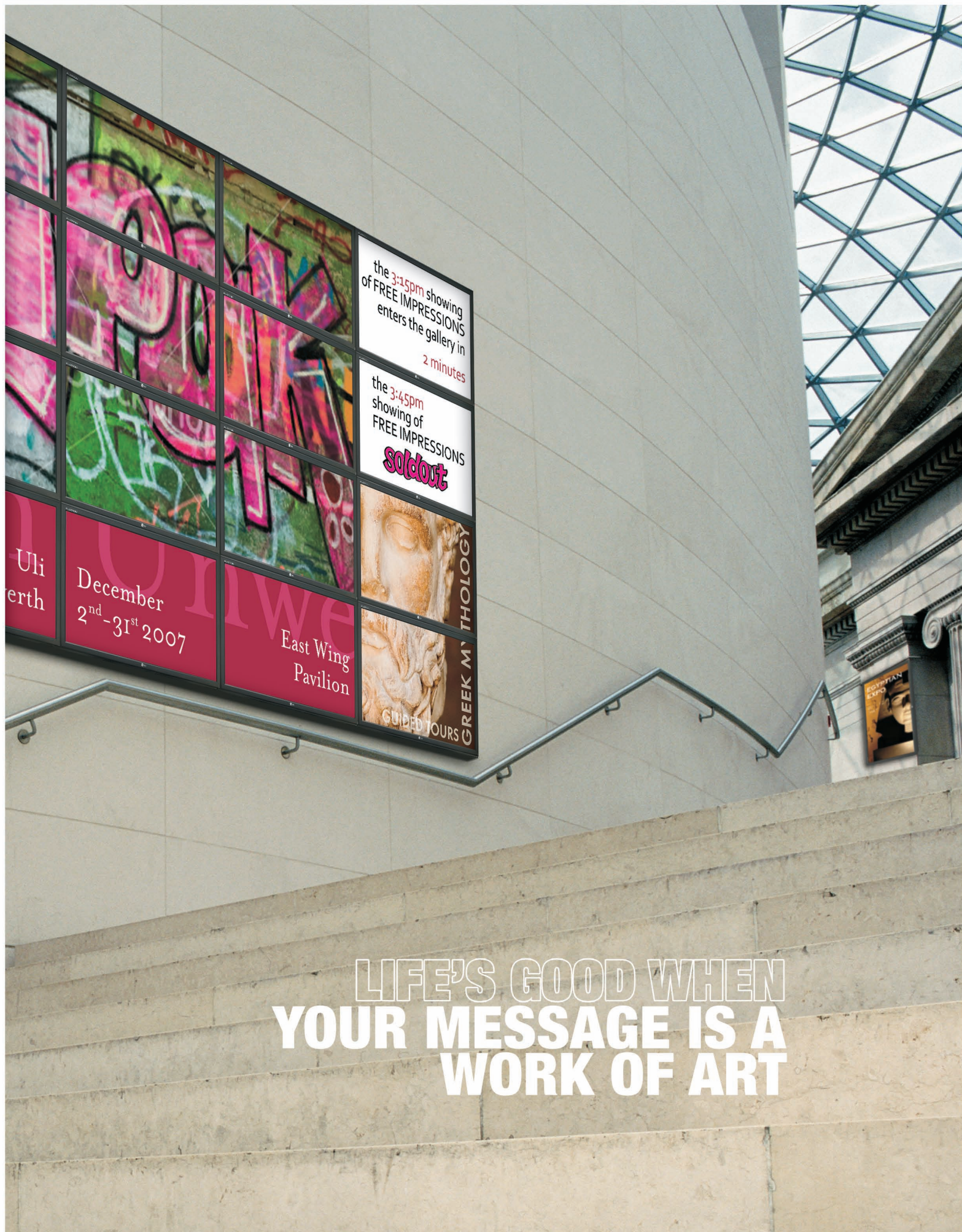

the 3:15pm showing
of FREE IMPRESSIONS
enters the gallery in
2 minutes

the 3:45pm
showing of
FREE IMPRESSIONS
SOLD OUT

GREEK MYTHOLOGY
GUIDED TOURS

Uli
Erth
December
2nd - 31st 2007

East Wing
Pavilion

LIFE'S GOOD WHEN
**YOUR MESSAGE IS A
WORK OF ART**

LCD MONITORS - HIDDEN SPEAKERS

LG's M3202C, M3702C, M4212C, M4224C, and M4714C come equipped with a newly designed back that will fit the optional one-size-fits-all hidden accessory speakers (SP0000K). Fitted for select LCD monitors, these optional speakers are neatly hidden from the front view to conserve space.

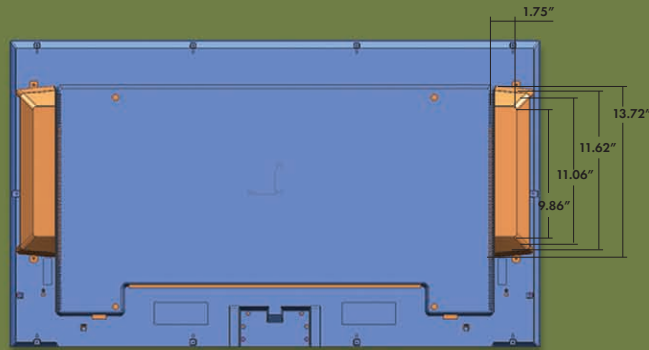

M4224C

Make use of the super thin bezel on the M4224C for use in a video wall configuration. With only 16.9mm narrow bezel, the video matrix image will come to life with little distraction from the bezel. The Split Zoom (Self Video Wall) function broadens your message allowing up to a grand 5 x 5 matrix automatically adjusting for bezel width.

NARROW BEZEL

Image area is the same on both matrices. With new, narrow bezels, image tiling appears significantly more natural.



DIGITAL RIGHTS MANAGEMENT SYSTEM

Pro:Idiom®

In public spaces that require protected HD content programming i.e. restaurant/bar, stadium, or health Club, LG has LCD televisions equipped with Pro:Idiom technology. The Pro:Idiom system's high-quality security unlocks access to premium content availability to help assure rapid, broad deployment of HDTV and other high value digital content. Pro:Idiom has been designed specifically for industries that use premium HDTV content from cable, satellite or video on demand (VOD) services and as such, could result in lower costs, and reduced maintenance. This system is one of the leading DRM systems embraced by content providers for both of these key programming sources. By using this embedded approach, security is provided and helps eliminate the possibility of customers tampering with or removing needed components.

FREE-TO-GUEST MANAGEMENT SYSTEM

For delivery of Free-To-Guest (FTG) content to large scale venues, virtual channel mapping and other adjustments can be made from a centralized location using LG's new Free-To-Guest Management Appliance (FMA). The FMA will connect to LG televisions with an LMT7Z7 FTG card installed or sets with the LMT7Z7 technology built-in.



FMA-100 FREE-TO-GUEST MANAGEMENT APPLIANCE

FMA HEAD-END CONTROL

- Manage channel line-up changes
- Manage channel label changes
- Ability to enable Pro:Idiom tuning for Pro:Idiom encrypted content
- One way communication from FMA
- Ability to designate a startup channel
- Ability to set the time/date, and broadcast that information to all the terminals on a regular basis

OTHER BENEFITS OF LMT7Z7 AND FMA SYSTEM

- LMT7Z7 gives the property the option of using the card with their current channel programming provider or changing to another provider (card is universal)
- Future migration to other current Pay-Per-View providers



LMT7Z7 FREE-TO-GUEST CARD

Unlocks Pro:Idiom encrypted programs in the TV in properties without a Pro:Idiom based pay-per-view system.





XD ENGINE

ULTRA CONTRAST

At a blazingly fast 370 million pixels per second, the processor uses a histogram analysis tool to clarify the image data according to signal brightness levels.

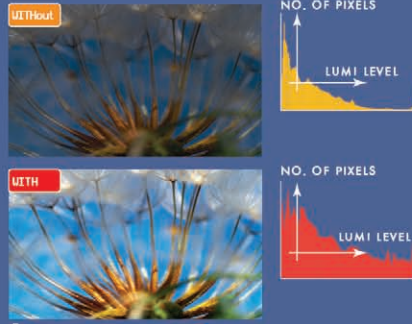

Dramatizations

DYNAMIC BLACK STRETCH

The minimum black level of an image is automatically detected and adjusted according to brightness.

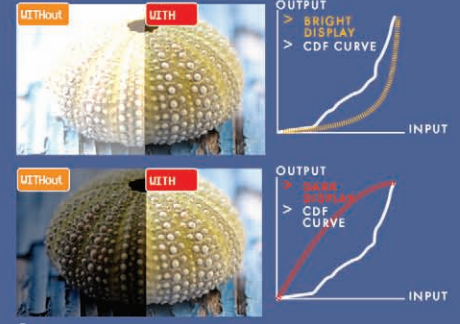

Dramatizations

CLEAR SCREEN

Using the noise filter inside the XD Engine[®] chip, the image is analyzed for temporal and spatial information to reduce MPEG noise.

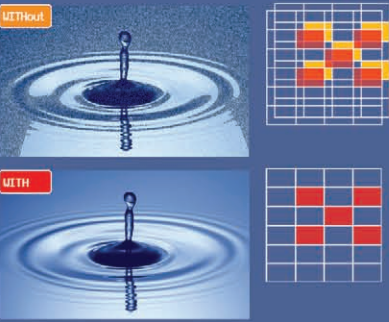

Dramatizations

ADVANCED VIVID COLOR

Colors that are sensitive to the human eye are optimized to the nearest TRUE color by the Selective Color Control.

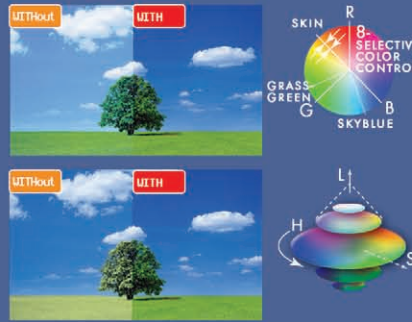

Dramatizations

INTELLIGENT EDGE CONTROL

Edge lines are emphasized by improving the transition from the background to the main object.

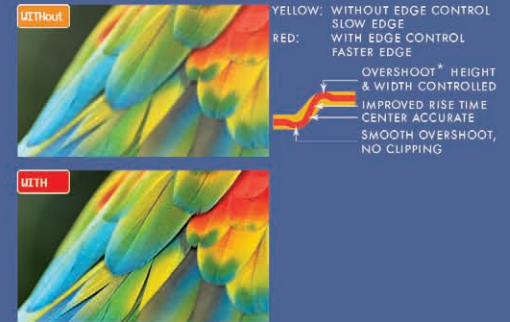

Dramatizations

SELF VIDEO WALL

Split zoom display to multiple screens by linking displays using a 15-pin d-sub signal cable



5x5 matrixing capabilities



3x3 matrixing capabilities



4x4 matrixing capabilities

PUBLIC DISPLAY SETTINGS

Cloning capable with TVLink-Loader

Public Display Settings

Public Display Mode	No
Start Channel	No
Ch. Type	TV
Major	2
Minor	0
Minimum Volume	0
Maximum Volume	100
Start Volume	No
Level	20
Power Management	No
Setting	1
Key Management	0
Factory Reset	0
Aspect Ratio	0

When used in public areas, select HDTV models can be easily programmed by the installer to have the TV turn on at a specified channel/volume level, set the minimum/maximum volume, lock out the control panel/remote, set the aspect ratio, and return to a factory reset. by using power management, these displays can be programmed to turn off if there has been no activity (remote or control panel buttons) for a preset time (1-7) hours.

PLASMA TVs

60PS60C 50PS60C

WUXGA HDTV with Full HD Resolution

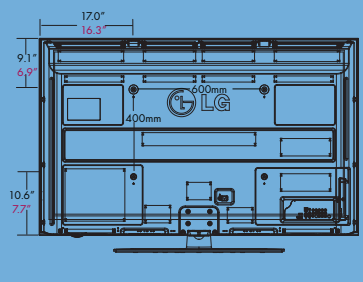
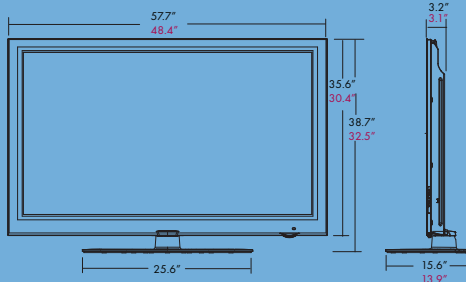

- 60" Class (59.5" Diagonal)
- 50" Class (50.0" Diagonal)
- Plasma Widescreen Commercial HDTV
- Full HD 1080p Resolution
- 1920 x 1080 Native Resolution
- EcoSmart - Energy Savings
- Intelligent Sensor - Automatic
- 3 Mode Power Saving Levels - Manual
- RoHS Compliant

- Frameless "Single Layer" Design
- Seamless Sheet of Glass
- Life Span (typical) 100,000 Hours to Half Brightness (approx.)
- Invisible Speaker System
- No Visible Speaker Grilles
- Built-In Tuners
- ATSC/NTSC/Clear QAM

- Public Display Settings - Cloning Capable with Optional TVLink-Loader, TLL-1100A
- **IMPROVED!** Dynamic Contrast Ratio 2,000,000:1
- **IMPROVED!** High Brightness 1500 cd/m²
- LG's Exclusive XD Engine
- ISFccc Calibration Ready

- 600Hz Sub-Field Driving
- THX Certified Display
- **IMPROVED!** 4 HDMI™ Inputs V.1.3 with Deep Color
- PC Input
- High-Gloss Black Cabinet
- Detachable Swivel (20°/20°) Stand
- 2-Year Limited Warranty (parts/labor)

50PQ30C 42PQ30C

HDTV

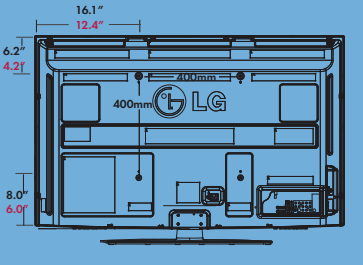
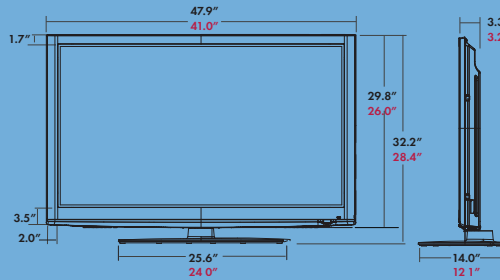

- 50" Class (50.0" Diagonal)
- 42" Class (41.6" Diagonal) Plasma Widescreen Commercial HDTV
- EcoSmart - Energy Savings
- Intelligent Sensor - Automatic
- 3 Mode Power Saving Levels - Manual
- RoHS Compliant
- Life Span 100,000 Hours (approx.) To Half Brightness (typical)

- Invisible Speaker System
- No Visible Speaker Grilles
- Built-In Tuner
- ATSC/NTSC/Clear QAM
- Public Display Settings
- Cloning Capable with Optional TVLink-Loader, TLL-1100A

- Native Display Resolution 1365 x 768 - 50" 1024 x 768 - 42"
- **IMPROVED!** Dynamic Contrast Ratio 2,000,000:1
- High Brightness 1500 cd/m²
- LG's Exclusive XD Engine
- ISFccc Calibration Ready
- 600Hz Sub-Field Driving

- USB Input For Photos, Music, and Video
- 3 HDMI™ Inputs with HDCP (V.1.3 with Deep Color)
- PC Input
- High-Gloss Black Cabinet
- Slim Depth 3.3" - 50", 3.2" - 42"
- Detachable Swivel (20°/20°) Stand
- 2-Year Limited Warranty (parts/labor)

LCD MONITORS

M5201C-BA

WUXGA Full HD Capable Monitor*

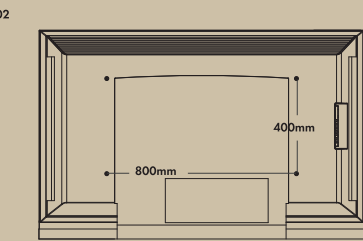
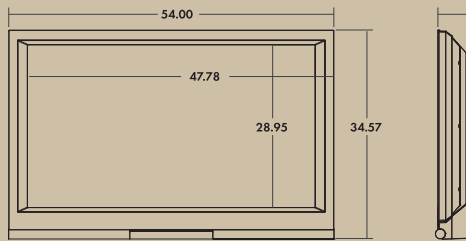

- 52" Class (52.0" Diagonal) LCD Widescreen Full HD Capable Monitor
- Full HD 1080p Resolution
- 1920 x 1080 WUXGA

- Contrast Ratio 1600:1 (dynamic) 800:1 (high)
- High Brightness 500 cd/m²
- Split Zoom (Self Video Wall) up to 4x4 Matrix - Adjusts for Bezel Width

- LG Exclusive XD Engine
- Temperature and Lamp Fault Sensor
- HDMI with HDCP
- RS-232C Control

- Cabinet Color Matte Black 63mm Bezel
- 3-Year Limited Warranty (parts/labor)

M4714C-BA

WUXGA Full HD Capable Monitor*

M4714T-BA

Touch Screen Monitor

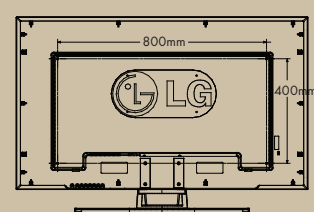
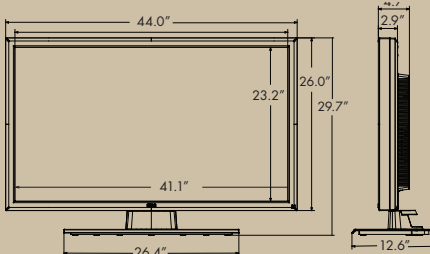

- 47" Class (46.9" Diagonal) LCD Widescreen Full HD Capable Monitor
- Native Display Resolution 1920 x 1080 (WUXGA)
- High Brightness 500 cd/m²
- Contrast Ratio 3000:1 (DCR)
- Super IPS 178° Viewing Angle

- 3m DST Integrated Touch with Fast, Accurate Touch Response - (M4714T-BA)
- Viewing Angle and Life Expectancy Enhanced in Portrait and Landscape Mode
- Narrow Bezel 36mm
- RS-232C Control
- HDMI with HDCP

- RoHS Compliant
- Convenient External Speaker-out
- Information Display for Serial Number
- Split Zoom (Self Video Wall) Up to 5 x 5 Matrix - Adjusts for Bezel Width
- Optional Hidden Speakers (SP0000K)
- Optional Stand (ST4710K)
- 3-Year Limited Warranty (parts/labor)

NOTE: Model M4714T-BA is brought to you by LG and Kristel Displays. To order, contact your Kristel Displays representative at 630.443.1290 ext.103

KRISTEL
DISPLAYS

LCD MONITORS

M4210D-B21

WUXGA Full HD
Capable 3D Monitor*



- 42" Class (42.0" Diagonal) LCD Widescreen Full HD Monitor with 3D (no 3D glasses required)
- 3-Dimension Display
- 3D depth 90cm
- Full HD Display Resolution 1920 x 1080

- Built-in Controller Celeron M™ 430 (1.86G) with IP Function
- Bundled Software for Content Creation
- Utilizes Content from Still Images, Dynamic Animation, 2D & 3D Movies
- Narrow Bezel (29mm)

- Convenient External Speaker-Out
- Split Zoom (Self Video Wall) up to 4x4 Matrix-Adjusts for Bezel Width
- DVI and RGB Interface
- On-Screen Display and Remote Control Lock

- RS-232C Control
- Optional Speaker (SP4210K) and Optional Stand (ST4210K)
- RoHS Compliant
- 3-Year Limited Warranty (parts/labor) (1-Year for Controller)

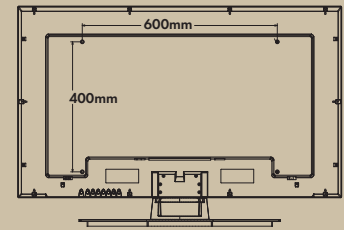
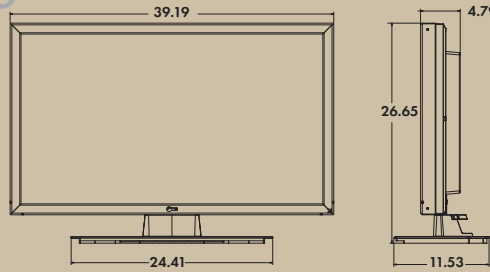

M4210N-B21

WXGA HD
Capable Monitor*



- 42" Class (42.0" Diagonal) LCD Widescreen HDTV Monitor with Built-In Controller
- Narrow Bezel (29mm)
- 1366 x 768 (WXGA) Display Resolution

- Built-in Wired and Wireless LAN
- Convenient External Speaker-Out
- Viewing Angle and Life Expectancy Enhanced in Portrait Mode
- Split Zoom (Self Video Wall) up to 4x4 Matrix - Adjusts for Bezel Width

- 500 cd/m² Brightness
- 800:1 Contrast Ratio
- RGB and DVI Interface
- Super IPS 178° Viewing Angle
- OSD and Remote Control Lock

- RS-232C Control
- 10W 2ch Speakers (optional)
- Optional Speaker (SP4210K) and Optional Stand (ST4210K)
- 3-Year Limited Warranty (parts/labor) (1-Year for Controller)

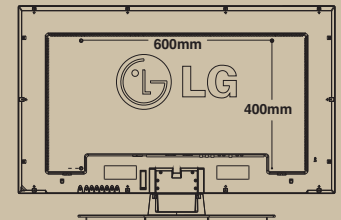
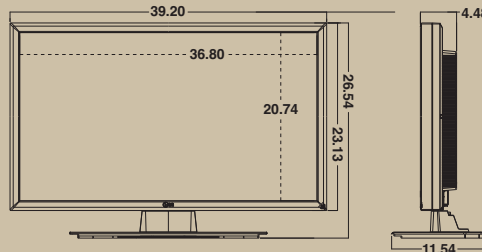

M4224C-BA

WUXGA Full HD
Capable Monitor*



- 42" Class (42.0" Diagonal) LCD Widescreen Full HD Capable Monitor
- Native Display Resolution 1920 x 1080 (WUXGA) Full 1080p Resolution
- **IMPROVED!** Ultra Thin Narrow Bezel 16.9mm (0.67")

- Backlight Control
- **NEW!** LAN Control
- Convenient External Speaker-Out
- Information Display for Serial Number
- Viewing Angle and Life Expectancy Enhanced in Portrait Mode

- Split Zoom (Self Video Wall) up to 5 x 5 Matrix - Adjusts for Bezel Width
- **IMPROVED!** High Brightness 700 cd/m²
- Contrast Ratio 3000:1 (DCR)
- HDMI with HDCP
- Super IPS 178° Viewing Angle

- OSD and Remote Control Lock
- RS-232C Control
- Optional Hidden Speakers (SP0000K) and Optional Stand (ST0000K)
- RoHS Compliant
- 3-Year Limited Warranty (parts/labor)

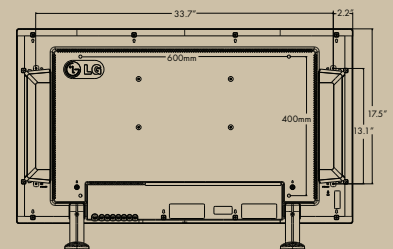
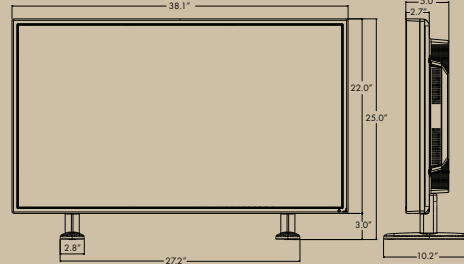

f·ENGINE™

INTEGRATED TECHNOLOGY FOR IMPROVING PICTURE QUALITY IN DESKTOP LCD MONITORS

FLESH TONES



Dramatizations

NATURE TONES



Dramatizations

SPORT TONES



Dramatizations

COLOR PROFILES



Dramatizations

LCD MONITORS

M4212C-BA

WXGA HD
Capable Monitor*

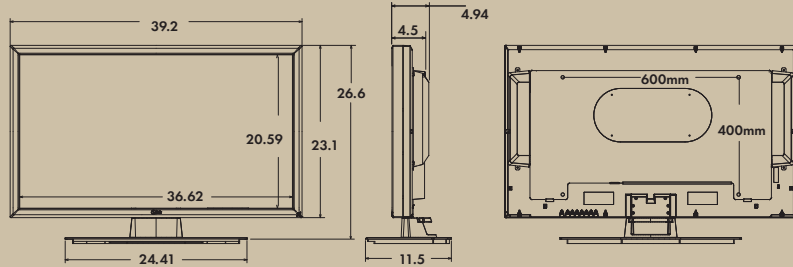

M4212T-BA

Touch Screen Monitor

- 42" Class (42.0" Diagonal) LCD Widescreen HD Capable Monitor
- Native Display Resolution 1366 x 768 (WXGA)
- 3M DST Integrated Touch with Fast Accurate Touch Response (**M4212T-BA**)
- High Brightness 500 cd/m²

- Contrast Ratio 3000:1 (DCR)
- Super IPS 178° Viewing Angle
- Viewing Angle and Life Expectancy Enhanced in Portrait & Landscape Mode
- Narrow Bezel 22mm
- HDMI with HDCP
- RS-232C Control

- Convenient External Speaker-Out
- RoHS Compliant
- Information Display for Serial Number
- Split Zoom (Self Video Wall) Up to 5 x 5 Matrix - Adjusts for Bezel Width
- Optional Hidden Speakers (SP0000K) and Optional Stand (ST4210K)

- 3-Year Limited Warranty (parts/labor)

NOTE: Model M4212T-BA is brought to you by LG and Kristel Displays. To order, contact your Kristel Displays representative at 630.443.1290 ext.103



M3702C-BA

M3202C-BA

WXGA HD
Capable Monitor*

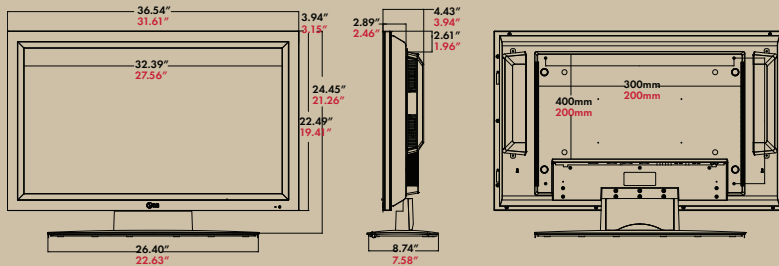

M3202T-BA

Touch Screen Monitor

- 37" Class (37.0" Diagonal) **32" Class (31.5" Diagonal)** LCD Widescreen HD Capable Monitor
- Native Display Resolution 1366 x 768
- High Brightness 500 cd/m²
- Contrast Ratio 3000:1 (DCR)
- Super IPS 178° Viewing Angle

- 3m DST Integrated Touch with Fast, Accurate Touch Response - (**M3202T-BA**)
- Viewing Angle and Life Expectancy Enhanced in Portrait Mode - **32"**
- HDMI with HDCP
- RS-232C Control
- Convenient External Speaker-Out

- RoHS Compliant
- Information Display for Serial Number
- Split Zoom (Self Video Wall) Up to 5 x 5 Matrix - Adjusts for Bezel Width
- Temperature Sensor
- Optional Hidden Speakers (SP0000K)
- Optional Stands for 37" (ST3700K), **32"** (ST3200K)

- 3-Year Limited Warranty (parts/labor)

NOTE: Models M3202T-BA are brought to you by LG and Kristel Displays. To order, contact your Kristel Displays representative at 630.443.1290 ext.103



M3800S-BN

M2900S-BN

Stretch Screen Monitors

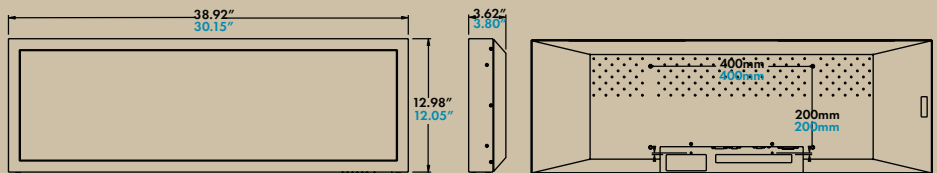

- 38" Class (38.1" Diagonal) **29" Class (29.1" Diagonal)**
- Native Display Resolution 1366 x 398 - **38"** 1366 x 480 - **29"**

- Contrast Ratio 1,000:1
- High Brightness 450 cd/m²
- Response Time 8ms (G to G)
- Viewing Angle 178° H/178° V
- RS-232C Control

- RGB and DVI Interface
- Black Bezel
- VESA™ standard Mounting Compatible
- 3-Year Limited Warranty (parts/labor)

OPTIONAL ACCESSORIES

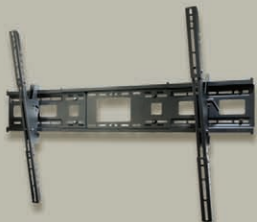

PWMT300 PEERLESS® WALL MOUNT

- Fits select LG 23" - 60" flat panel screens
- Easily expandable adapter brackets and wall plate
- Adjustable tilt of +15/-5° for viewing flexibility
- Portrait and landscape capability with mounting hole patterns up to 41"W and 26.37"H



PWMT300-AC1 WALL MOUNT ACCESSORY FOR PWMT300

- Attaches to Peerless PWMT300
- For mounting LG commercial LST-4100B and HCS5610 set-top-boxes behind LG flat panel monitors/TVs

HIDDEN SPEAKERS SP0000K

Dimensions (WxHxD) 2.88" x 13.72" x 2.17"
Weight 0.80 lbs. each
10 Watts

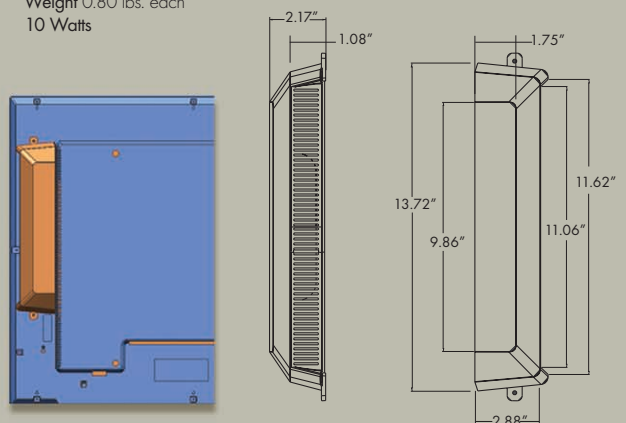

SMALL SCREEN LCD DISPLAYS

W2600V-PF
WUXGA Monitor

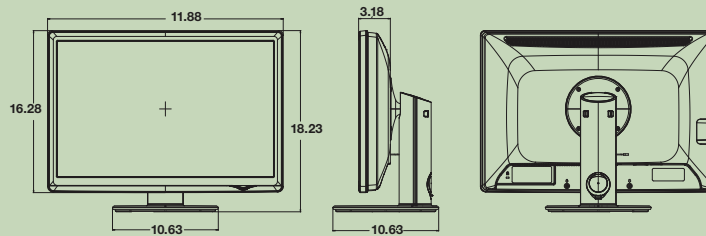

- 26" Class (25.5" Diagonal) LCD Widescreen Monitor
- 1920 x 1200 WUXGA Resolution
- 5000:1 (DFC) Contrast Ratio
- 300 cd/m² Brightness

- 5ms Response Time
- Viewing Angle 170° H/170° V
- Integrated f-ENGINE™ (Picture-Quality Enhancing Chip)
- Supports Full HD (1080p)

- HDMI, DVI-D with HDCP, VGA Analog (15-pin D-sub) Inputs
- Built-In USB 2.0 Hub (1 up/4 down)
- Picture-In-Picture
- Tilt, Swivel, and Height Adjustable (100mm) Stand
- 3-year Quick Swap Limited Warranty

W2442PA-BF
WUXGA Monitor

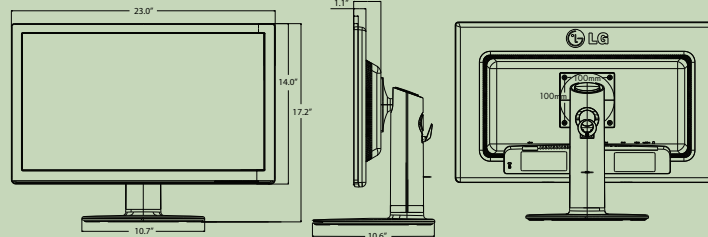

- 24" Class (24.0" Diagonal) LCD Widescreen Monitor
- 1920 x 1080 WUXGA Resolution
- 10,000:1 (DFC) Contrast Ratio

- 300 cd/m² Brightness
- 5ms Response Time
- Viewing Angle 170° H/160° V
- Integrated f-ENGINE (Picture-Quality Enhancing Chip)

- Supports Full HD (1080p)
- HDMI, DVI-D with HDCP, VGA Analog (15-pin D-sub) Inputs
- Tilt, Swivel, and Height Adjustable Stand
- RoHS Compliant
- 3-year Quick Swap Limited Warranty

W2242P-BS
WSXGA Monitor

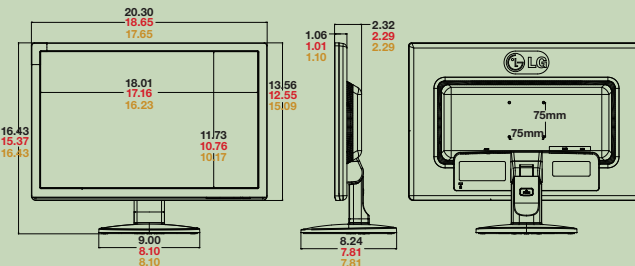

- 22" Class (22.0" Diagonal) LCD Widescreen Monitor
- 1680 x 1050 WSXGA Resolution
- 8000:1 (DFC) Contrast Ratio

- 300 cd/m² Brightness
- 5ms Response Time
- Viewing Angle 176° H/170° V

- Integrated f-ENGINE (Picture-Quality Enhancing Chip)
- DVI-D with HDCP, VGA Analog (15-pin D-sub) Inputs
- Tilt, Pivot, and Height Adjustable Stand
- 3-year Quick Swap Limited Warranty

W1934S-BN
WSXGA Monitor

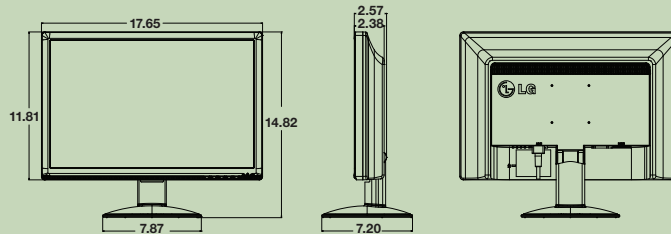

- 19" Class (18.9" Diagonal) LCD Widescreen Monitor
- 1440 x 900 WSXGA Resolution

- 1000:1 Contrast Ratio
- 300 cd/m² Brightness
- 5ms Response Time

- Viewing Angle 170° H/170° V
- VGA Analog (15-pin D-sub) Inputs
- 3-year Quick Swap Limited Warranty

L1734S-BN
SXGA Monitor

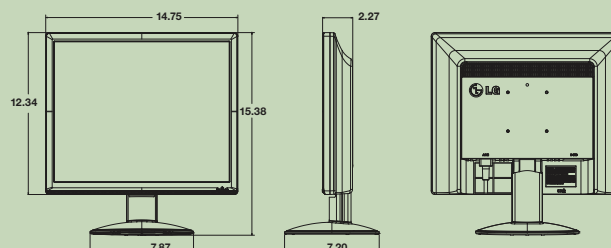

- 17" Class (17.0" Diagonal) LCD Monitor
- 1280 x 1024 SXGA Resolution

- 700:1 Contrast Ratio
- 300 cd/m² Brightness
- 5ms Response Time

- Viewing Angle 170° H/170° V
- VGA Analog (15-pin D-sub) Inputs
- Tilt Adjustable Stand
- 3-year Quick Swap Limited Warranty

LCD TVs with Public Display Settings

52LG50DC

HDTV Full 1080p

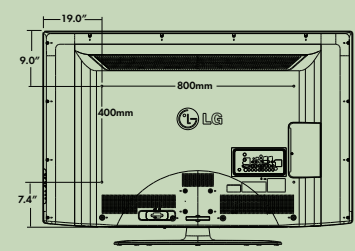
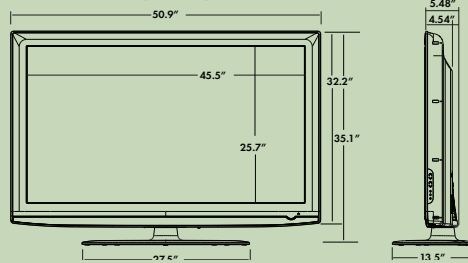

- 52" Class (52.0" Diagonal) LCD Widescreen Full 1080p HDTV
- Native Display Resolution 1920 x 1080 (1080p Full HD Resolution)
- Backlight Dimming Control Provides Power Savings
- Intelligent Sensor
- Dynamic Contrast Ratio 15,000:1
- Built-In Tuner ATSC/NTSC/Clear QAM
- Public Display Settings
- Cloning Capable
- LG's Exclusive XD Engine
- Real Cinema™
- Clear Voice
- 2 HDMI with HDCP
- USB Input for Photos and Music
- RoHS Compliant
- Invisible Speaker System
- Customizable Closed Captions
- **NEW!** 2-Year Limited Warranty (parts/labor)

47LH300C

42LH300C

HDTV Full 1080p

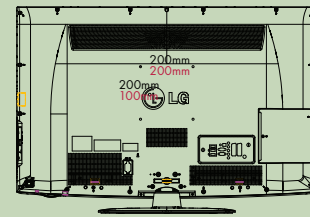
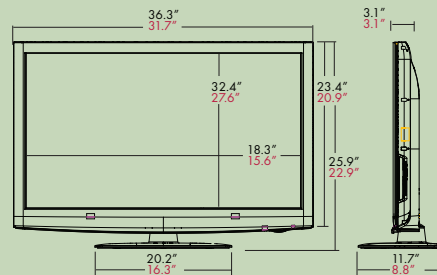

- 47" Class (47.0" Diagonal)
- **42" Class (42.0" Diagonal)**
- LCD Widescreen Full HD 1080p
- Full HD 1080p Display Resolution
- Public Display Settings - Cloning Capable
- EcoSmart - Energy Saving Levels
- RoHS Compliant
- USB Cloning and Media Host (MP3 & JPEG)
- Native Display Resolution 1920 x 1080
- Auto-Sensing Remote Jack Pack Compatible
- Cabinet: High-Gloss Black, Invisible Speaker System, 40° Swivel Stand
- 2-Year Limited Warranty (parts/labor)

42LH200C

37LH200C

32LH200C

22LH200C

HDTVs

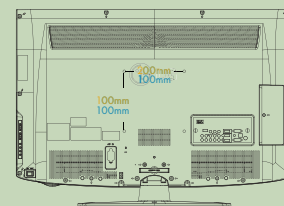
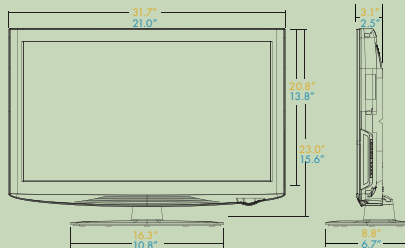
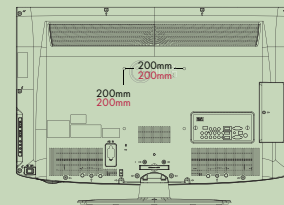
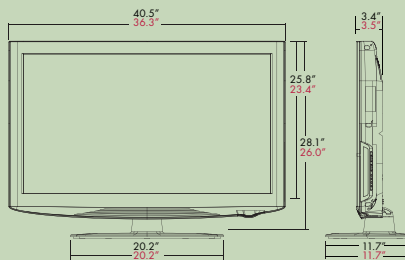

- 42" Class (42.0" Diagonal)
- **37" Class (37.0" Diagonal)**
- **32" Class (31.5" Diagonal)**
- **22" Class (21.6" Diagonal)**
- LCD Commercial Widescreen Integrated HDTVs
- Public Display Settings - Cloning Capable
- EcoSmart - Energy Saving Levels
- RoHS Compliant
- Dynamic Contrast Ratio 50,000:1 - 42"/37"/32"
- 3,000:1- 22"
- Native Display Resolution 1366 x 768
- Built-In ATSC/NTSC/QAM Clear Tuner
- Invisible Speaker System
- LG's Exclusive XD Engine
- Auto Sensing Remote Jack Pack (RJP) Compatible 42"/37"/32"
- USB 2.0 Media Host for Photos and Music 42"/37"/32"
- USB Cloning 42"/37"/32"
- Clear Voice II
- Real Cinema™
- 2 HDMI Inputs with HDCP V.1.3 with Deep Color - 42"/37"/32"
- 2-Year Limited Warranty (parts/labor)

LCD TVs with Integrated Pro:Idiom

42LG500H
37LG500H/505H/515H
32LG500H/515H/515H

HDTVs

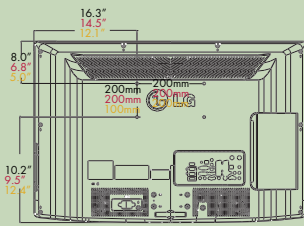
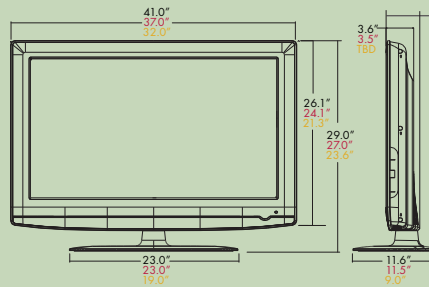

- 42" Class (42.0" Diagonal)
37" Class (37.0" Diagonal)
32" Class (31.5" Diagonal)
LCD Widescreen HDTV with HD-PPV Capability
- New! built-in LMT7Z7 Card*
Includes Full Support of: LodgeNet®'s HD Video on Demand (VOD)
LodgeNet's HD Free-To-Guest (FTG)
Supports Many Other FTG System Providers (See Sales Rep) (515H Series)

- EcoSmart
Intelligent Sensor
Dynamic Power Savings
Static Power Savings
- RoHS Compliant
- HD VOD PPV Encryption
Integrated Pro:Idiom
- MPEG-2/MPEG-4 H.264 decoding
- **IMPROVED!** Dynamic Contrast
Ratio 20,000:1

- Native Display Resolution
1366 x 768
- Built-In Tuner
ATSC/NTSC/QAM Clear
- LG's Exclusive XD Engine
- Split Screen Using Optional Auto-Sensing Remote Jack Pack (RJP)
- **NEW!** Invisible Speaker Cabinet Style. Includes 180° Swivel Base
- Auto-Sensing Remote Jack Pack (RJP) Compatible

- Optional Security Screws Included
- Customizable Closed Captions
- 2 HDMI Inputs with HDCP
- Cabinet Color Hi Gloss Black - LG500H, Matte Black - LG505H, LG515H
- 2-Year Limited Warranty (parts/labor)

42LH250H
32LH250H/255H
32LH250H/255H

HDTVs

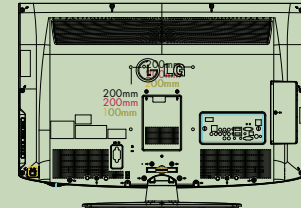
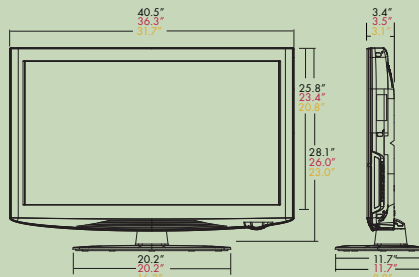

- 42" Class (37.0" Diagonal)
32" Class (31.5" Diagonal)
32" Class (31.5" Diagonal)
LCD Widescreen HDTVs with b-LAN
- EcoSmart - Energy Saving Levels
- RoHS Compliant

- HD VOD PPV Encryption
Integrated Pro:Idiom
- MPEG-2/MPEG-4 H.264 Decoding
- **IMPROVED!** Dynamic Contrast
Ratio 20,000:1
- Native Display Resolution
1366 x 768

- Built-In ATSC/NTSC/QAM
Clear Tuner
- LG's Exclusive XD Engine
- **NEW!** Invisible Speaker Cabinet style. Includes 40° Swivel Base
- Auto-Sensing Remote Jack Pack (RJP) Compatible
- Security Screws Included (optional use)

- Customizable Closed Captions
- 2 HDMI Inputs with HDCP
- Cabinet Color High Gloss Black - LH250H, Matte Black - LH255H
- 2-Year Limited Warranty (parts/labor)

FINANCING YOUR DIGITAL SIGNAGE SOLUTION

LG delivers customized financial solutions for our customers, resellers, distributors, and intermediaries by freeing up the necessary capital to sustain and enhance the sale of products and solutions to businesses in the United States. Contact your LG Commercial Account Manager for more information on financing options.

*LCD HD capable monitors require an optional set-top box to receive high-definition broadcast.

Dimensions and weights are approximate. Design specifications and features subject to change without notice.

© Copyright 2010 LG Electronics USA, Inc. All Rights Reserved. LG "Life's Good" is a registered trademark of LG Corp.

Screen images are simulated. Super IPS, XD Engine, EcoSmart, are registered trademarks or trademarks of LG Electronics, Inc. Pro:Idiom is a trademark of Zenith Electronics Corp. VESA™ is a registered trademark of Video Electronics Association. Windows Vista is a trademark of Microsoft Corporation in the United States and/or other countries. 3M is a trademark of 3M Company. All other corporate and brand names are trademarks of their respective owners.

Printed in the USA. May 2010

LG Electronics U.S.A., Inc.
Business Solutions Division
2000 Millbrook Drive,
Lincolnshire, IL 60069

Contact: DSinfo@LGCommercial.com

Vertical Markets: 800.897.8788

Channel: 800.897.8871

Hospitality: 800.228.1236

Healthcare: 877.793.6484

Customer Service: 888.865.3026

TO ORDER TOUCH SCREEN MODELS M3202T-BA, M4212T-BA, OR M4714T-BA, CONTACT YOUR KRISTEL DISPLAYS REPRESENTATIVE AT 1.630.443.1290 x103

Kristel Displays 555 South Kirk Road, St. Charles, IL 60174. Contact information: Phone: 630.443.1290 x103, Fax: 630.443.1236. For more information visit www.kristel.com

www.LGcommercial.com



LG
Life's Good